

 **BENKOO METAL**®



**BENKOO METAL**

# DIRECTORY

■ **01** **INTRODUCE**

■ **02** **REPRESENTED MILL**

■ **03** **PRODUCT**

■ **04** **STOCKS INTRODUCTION**

■ **05** **MACHINING CAPABILITY**

■ **06** **TRADING**

# INTRODUCE



**BENKOO METAL** is a global distributor of prime tubes/pipes and bars in the energy and auto industry market. We pride ourselves on our ability to provide comprehensive material solutions for unique, real-time requirements for both steel products.

We integrate traditional and new era visions that enable us to create unlimited solutions for our clients both domestic and international. Our end goal is to provide our customers with the highest quality products at competitive prices in a timely manner, all while building a trusting and lasting relationship founded upon the highest level of professionalism and integrity.

We are the sales platform of Xinxing Pipes for overseas markets, which is top level stainless steel, nickel alloy pipes and extruded sections manufacturer.



# MAIN PRODUCTS

Producing Line	Size	Capacity	Main products
Hot extrusion	48-325mm OD 4.5-55mm WT	20000 Tons/Year	Stainless/Duplex/Super duplex Nickel alloy Clad seamless pipes Oval tube Extruded sections
Cold rolling Cold drawing	19-325mm OD 1.65-32mm WT	20000 Tons/Year	

- Nickel alloy: N08825, N08800, N06625, N06690, C276, Monel 400, N08028, N09925, N07718
- Stainless steel: TP304, TP316, TP347, TP321, S32154, 904L, 17-4PH, 15-5PH, TP410, TP420, TP446, 13Cr, S13Cr
- Duplex/Super duplex: S31803, S32205, S32750, S32760
- Clad pipes: 304L/20G, T12/GH800, N08825/T12, L360QS/N08825, etc.

# MAIN PRODUCTS

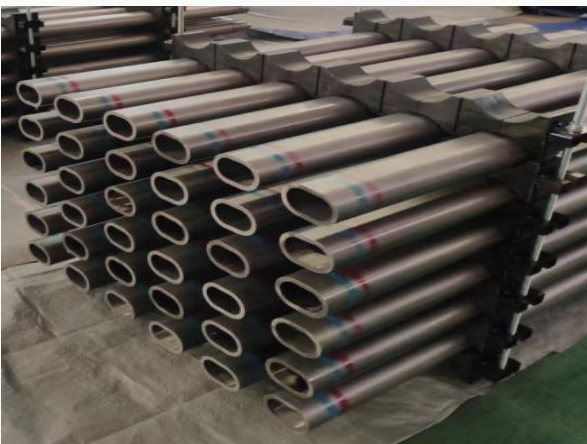

# MAIN PRODUCTS

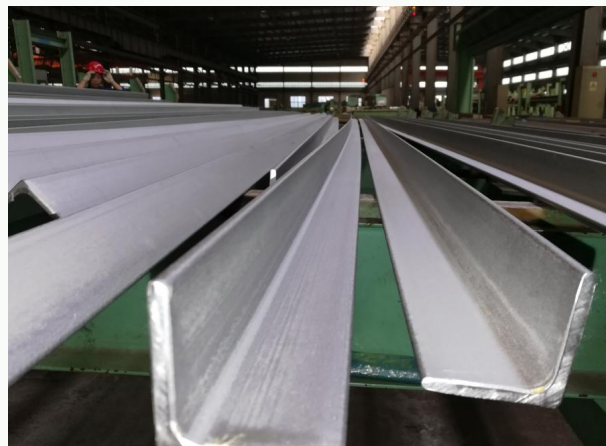
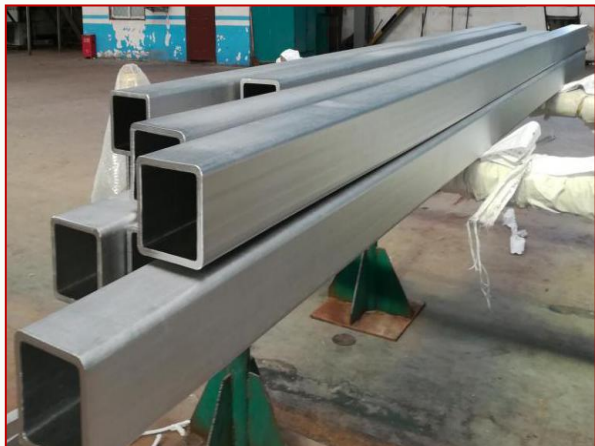

# MAIN PRODUCTS



# APPLICATIONS



■ Petrochemical Industry



■ OIL & GAS, FPSO, SHIP BUILDING

# APPLICATIONS



■ Paper-making Industry



■ Heat exchanger



■ Power generation

# EQUIPMENT



■ Hot extrusion (6300Tons)



■ Piercing (2500Tons)

# EQUIPMENT



■ Cold rolling & drawing



■ Heat Treatment



■ Straightening

# INSPECTION



■ UT

■ ET

■ Hydro test

# INSPECTION

(CNAS CERTIFICATED LAB)



- Chemical composition
- Mechanical properties
- Hardness
- Charpy testing
- Microstructure
- Corrossion Testing

# CERTIFICATES

- ◆ CNAS
- ◆ ISO 9001
- ◆ PED
- ◆ IATF 14969
- ◆ ABS
- ◆ DNV GL
- ◆ API Q1
- ◆ API 5CRA
- ◆ API 5CT
- ◆ API 5LC
- ◆ API 5DP



# CERTIFICATES



**American  
Petroleum  
Institute**



2018-151 | Digital

## Certificate of Authority to use the Official API Monogram

License Number: 5CRA-0005

ORIGINAL

The American Petroleum Institute hereby grants to

**XINXING DUCTILE IRON PIPES CO., LTD**  
No.1, Xinxing Street  
Hanshan District  
Handan City, Hebei  
People's Republic of China

the right to use the Official API Monogram® on manufactured products under the conditions in the official publications of the American Petroleum Institute entitled API Spec Q1® and **API-5CRA** and in accordance with the provisions of the License Agreement.

In all cases where the Official API Monogram is applied, the API Monogram shall be used in conjunction with this certificate number: **5CRA-0005**

The American Petroleum Institute reserves the right to revoke this authorization to use the Official API Monogram for any reason satisfactory to the Board of Directors of the American Petroleum Institute.

The scope of this license includes the following: Manufacturer of Casing, Tubing or Coupling Stock - PSL 2 Group 2 Category 25-7-4 UNS Number S32750 Grade 110 Delivery Condition CH and 80 Delivery Condition SA, Group 3 Category 27-31-4 UNS Number N08028 Grade 110 Delivery Condition CH and 125 Delivery Condition CH, Group 4 Category 21-42-3 UNS Number N08825 Grade 110 Delivery Condition CH and Category 22-50-7 UNS Number N06985 Grade 125 Delivery Condition CH

QMS Exclusions: Design

Effective Date: **MAY 9, 2024**  
Expiration Date: **JUNE 15, 2027**

Senior Vice President of Global Industry Services

To verify the authenticity of this license, go to [www.api.org/compositelist](http://www.api.org/compositelist).



**American  
Petroleum  
Institute**



2018-151 | Digital

## Certificate of Authority to use the Official API Monogram

License Number: 5CT-1418

ORIGINAL

The American Petroleum Institute hereby grants to

**XINXING DUCTILE IRON PIPES CO., LTD**  
No.1, Xinxing Street  
Hanshan District  
Handan City, Hebei  
People's Republic of China

the right to use the Official API Monogram® on manufactured products under the conditions in the official publications of the American Petroleum Institute entitled API Spec Q1® and **API-5CT** and in accordance with the provisions of the License Agreement.

In all cases where the Official API Monogram is applied, the API Monogram shall be used in conjunction with this certificate number: **5CT-1418**

The American Petroleum Institute reserves the right to revoke this authorization to use the Official API Monogram for any reason satisfactory to the Board of Directors of the American Petroleum Institute.

The scope of this license includes the following: Processor of Casing, Tubing, Coupling Stock, or Accessory Material (Plain End), Manufacturer of Seamless Casing or Tubing (Plain End) L80(13Cr), PSL 2, L80(9Cr), PSL 1; Manufacturer of Coupling Stock or Accessory Material L80(13Cr), PSL 3, L80(9Cr), PSL 1

QMS Exclusions: Design

Effective Date: **MAY 9, 2024**  
Expiration Date: **JUNE 15, 2027**

Senior Vice President of Global Industry Services

To verify the authenticity of this license, go to [www.api.org/compositelist](http://www.api.org/compositelist).

# APPROVALS



شركة تنمية نفط عُمان  
Petroleum Development Oman



**PERTAMINA**



**PETROBRAS**



**CNPC**

**Schlumberger**

**BAKER  
HUGHES**  
a GE company



**Weatherford**

# BENKOO METAL-- STOCKS INTRODUCTION



# BENKOO METAL-- STOCKS INTRODUCTION

**BENKOO METAL** keep thousands of tons  
13Cr/S13Cr/4145H/4330V/17-4/Alloy 718 pipes and  
bars in China for customer's urgent demand.

**We ensure delivery within 48 hours once order  
confirmed.**



# BENKOO METAL-- STOCKS INTRODUCTION

## BENKOO STOCK LIST

ITEM	Material	Type
1	17-4	SMLS PIPE
2	17-4	Solid bar
3	L80-13Cr	SMLS PIPE
4	L80-13Cr	Solid bar
5	Super13Cr	Solid bar
6	Super13Cr	SMLS PIPE
7	4140	SMLS PIPE
8	4145H	Solid bar
9	L80-9Cr	Solid bar
10	L80-9Cr	SMLS PIPE
11	718	Solid bar
12	4130M7/4330V	Solid bar



# BENKOO METAL-- MACHINING CAPABILITY



■ Small-Size CNC Lathe

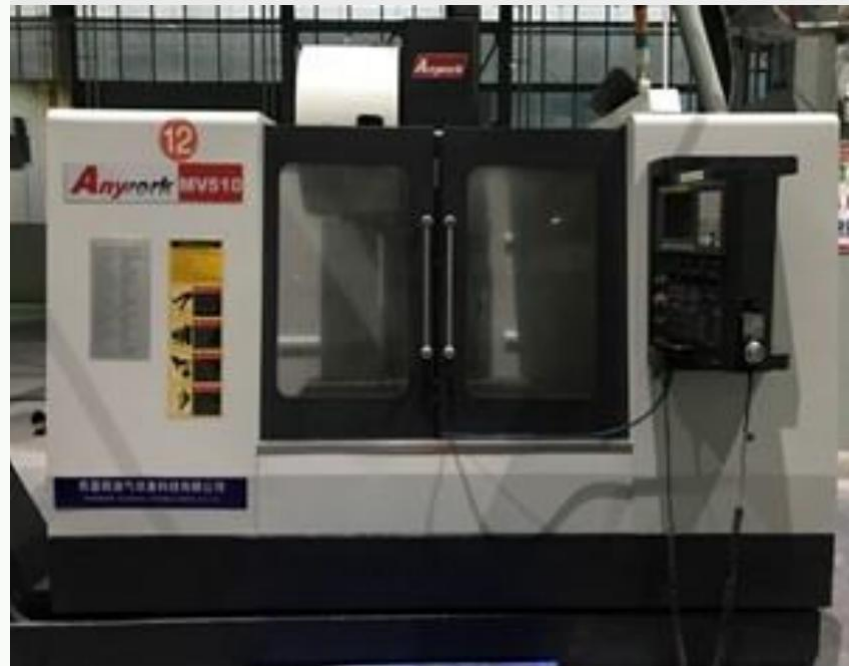

■ Small-Size VMC

# BENKOO METAL-- MACHINING CAPABILITY



■ 3M CNC Lathe

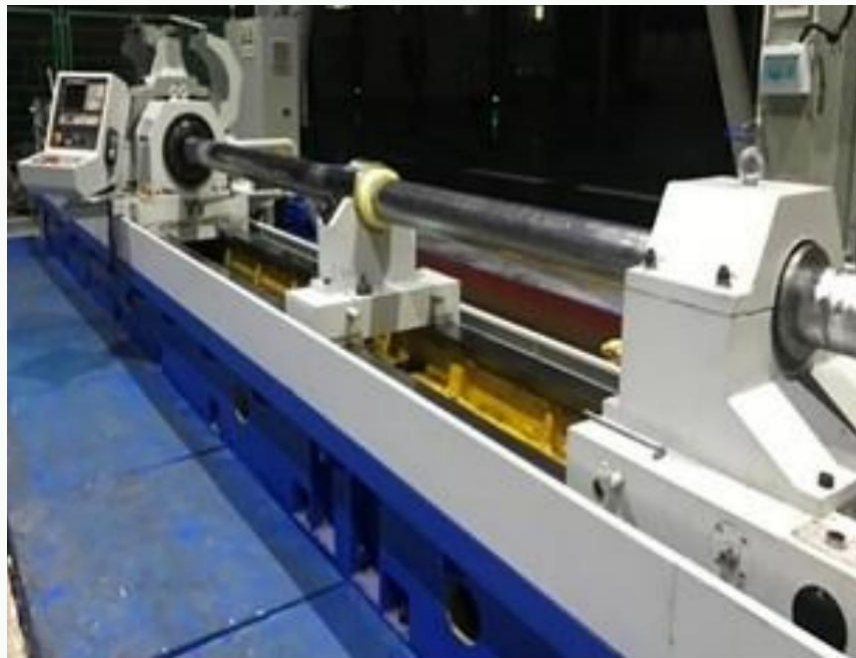

■ 3M Deep Hole Boring CNC Machine

# BENKOO METAL-- MACHINING CAPABILITY



■ 12 M Manual Lathe



■ 8M Deep Hole Hone/Bore Machine

# BENKOO METAL-- MACHINING CAPABILITY



■ 10M Phosphate Tank

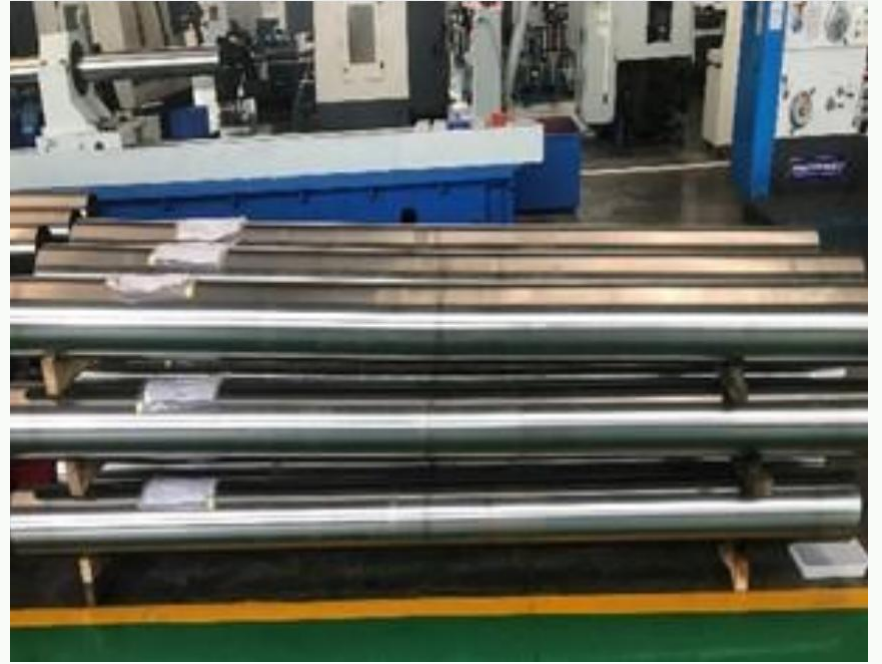

■ 25FT Polish Bore Receptacles

# BENKOO METAL-- MACHINING CAPABILITY

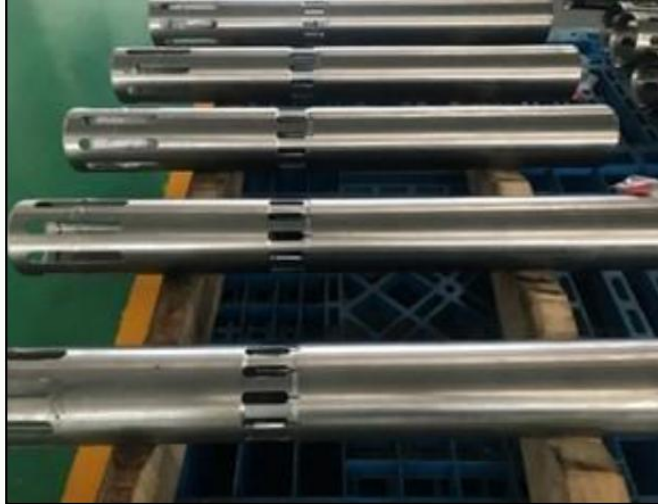

■ SSD INNER SLEEVE



■ For packer application

# BENKOO METAL-- MACHINING CAPABILITY



■ Drilled parts



■ For well logging application

# BENKOO METAL-- MACHINING CAPABILITY



- Follow customer's design to make it

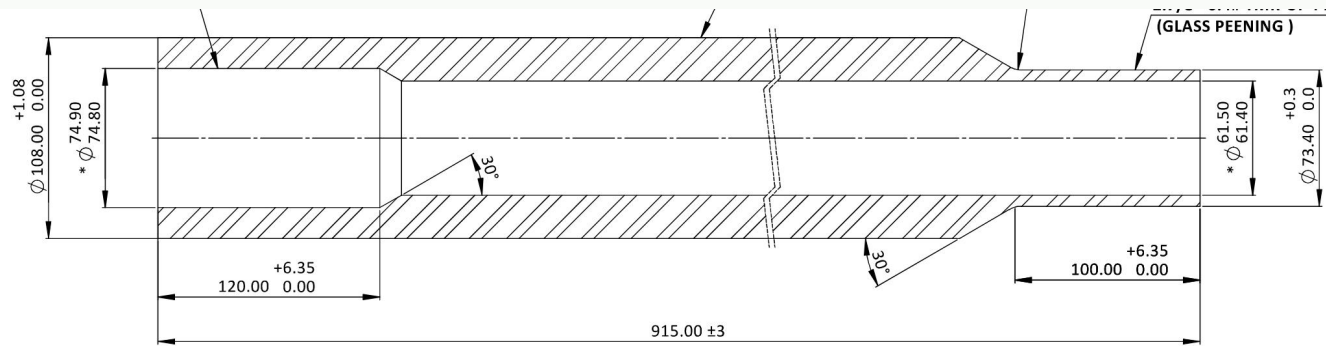

# BENKOO METAL-- TRADING BUSINESS

Supported by top level mills in China, **BENKOO METAL** is able to supply the metal products, extruded sections and machines for worldwide clients, including but not limited to:

- 1) Steel Pipes (SEAMLESS/WELDED) /Bars/Plates
- 2) Pipe Fittings and elbows
- 3) Extruded sections, stainless and aluminum material
- 4) Deep hole drilling machine
- 5) CNC and manual Lathe

**BENKOO METAL**

**Thank you!**

■ Mr. David Pan

■ M: +8618031061961

■ Email: [sales@benkoometal.com](mailto:sales@benkoometal.com)

